

A horizontal splash of clear water is shown in the middle of the slide, with droplets and ripples visible. The background behind the splash is a light, hazy blue.

Solutions for
a Sustainable Future

A large, circular, beige-colored reverse osmosis (RO) membrane disc is shown on the left side of the slide. It has a central hub and several radial spokes. The membrane surface has a fine, woven texture.

**The Innovative Energy Effective
Seawater Desalination RO System
with Advanced Key Technologies:
“Mega-ton Water System”**

Yoshinari Fusaoka, Hiromu Takeuchi, Masaru Kurihara
Toray Industries, Inc.,

2-1-1 Nihonbashi-muromachi, Chuo-ku, Tokyo 103-8666, Japan,

Tel. +81 (3) 3245 4878,

E-mail: Yoshinari_Fusaoka@nts.toray.co.jp

History of desalination plant as capacity of each technology

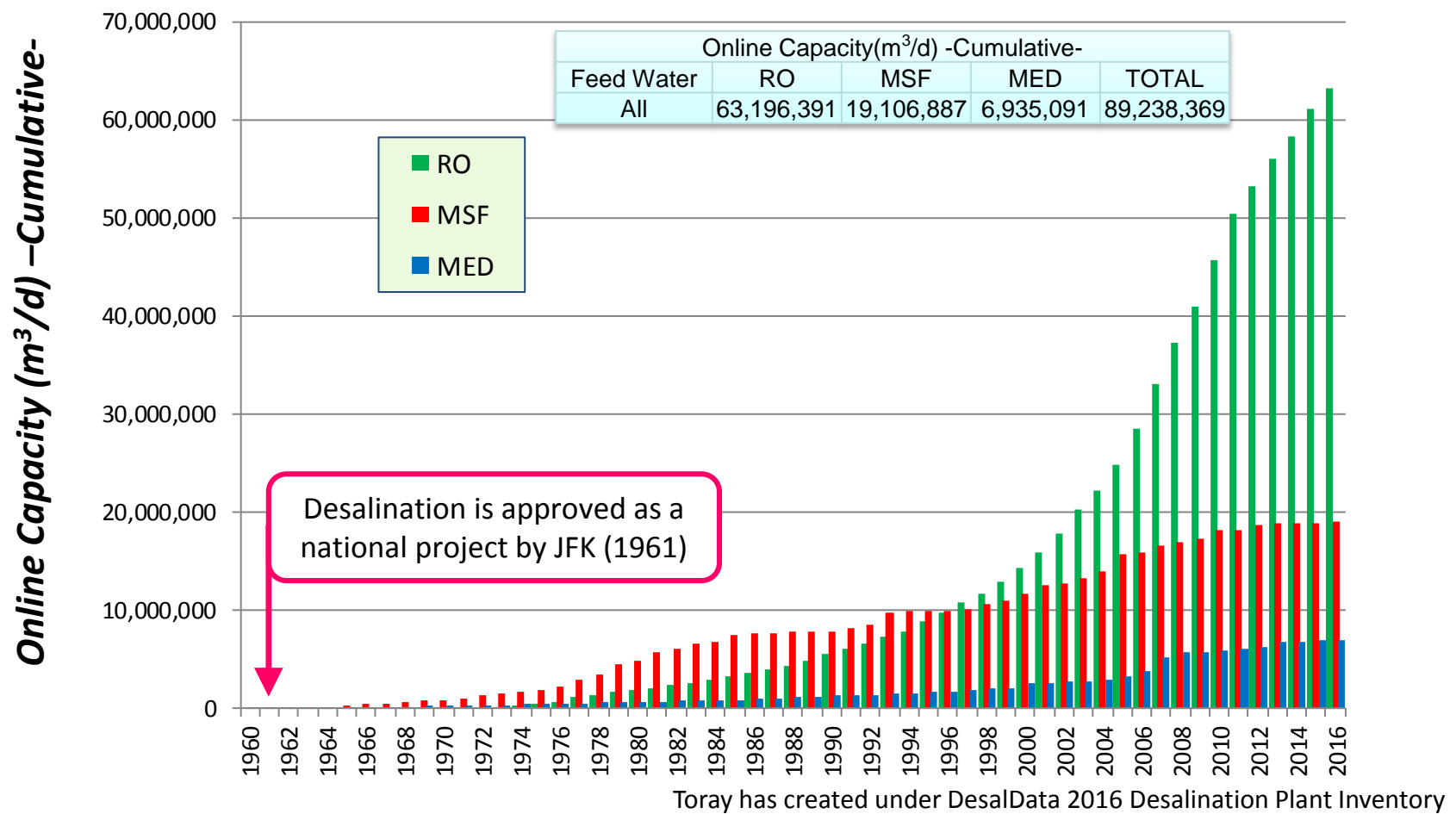

A total capacity of desalination plant has been increasing.
 Especially RO become the main technology
 A larger plant would be required for the future water demand.

The World Global Desalination Market

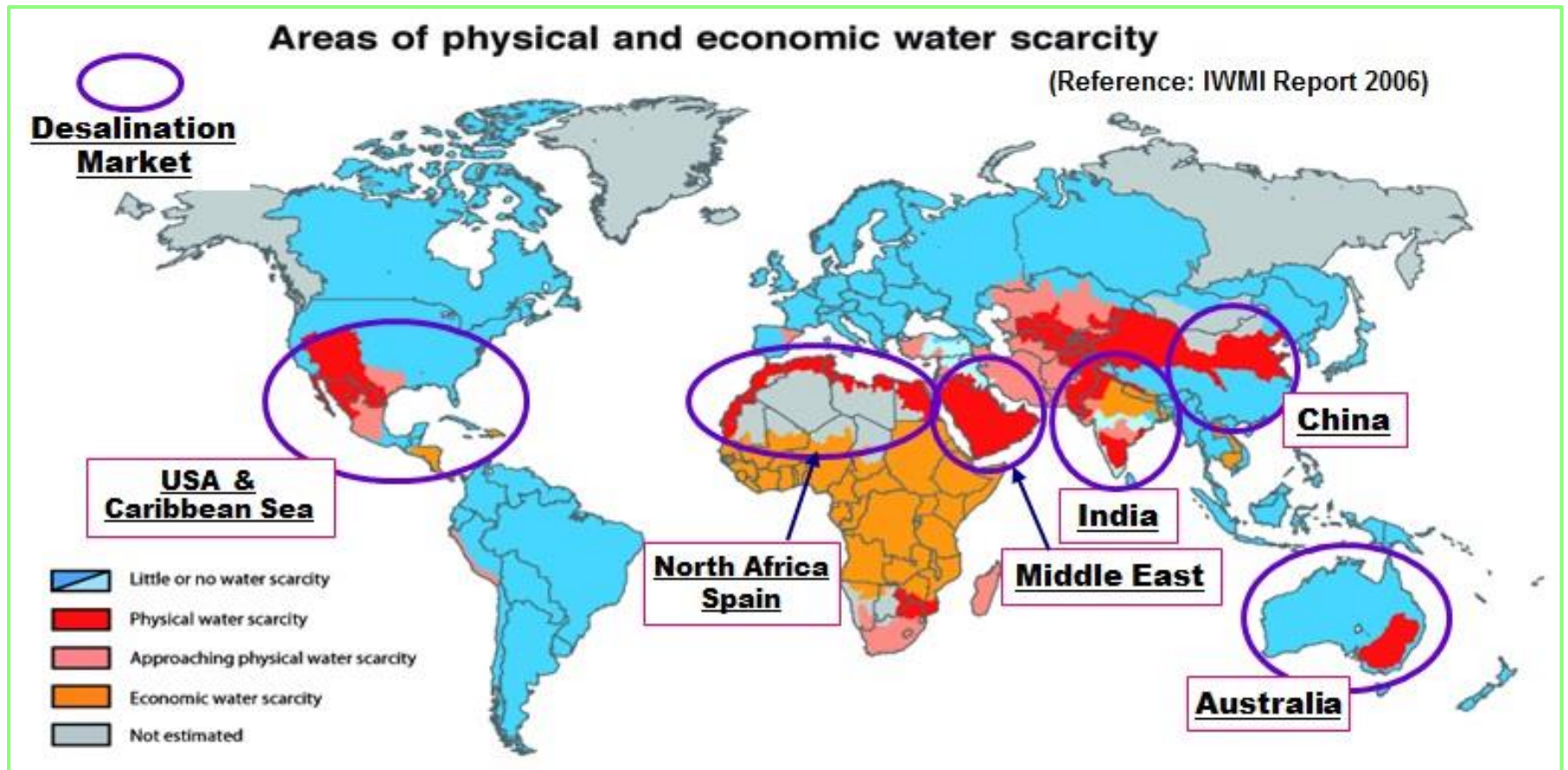

Middle East, North Africa, USA & Caribbean Sea, China, India and Australia are the main desalination Market.

Worldwide Desalination Facility by Country

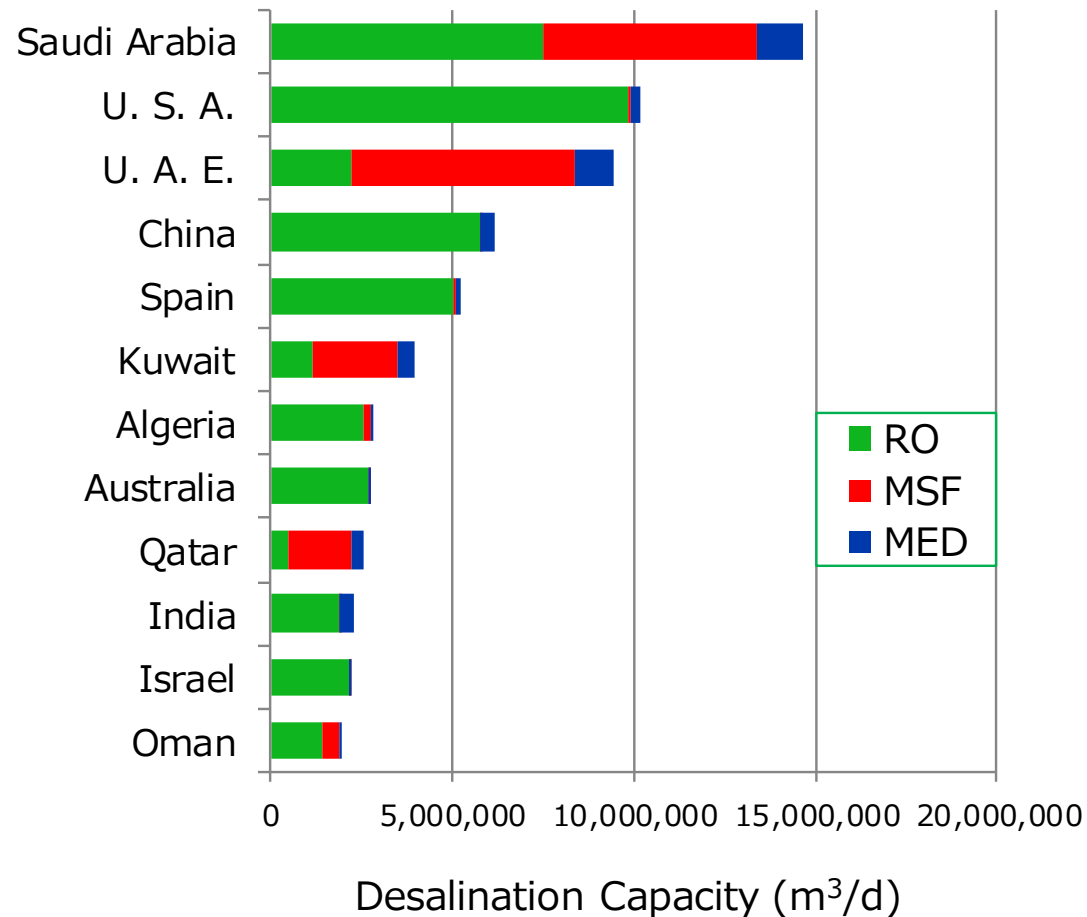

Kingdom of Saudi Arabia is the most important country in worldwide desalination market.

“Mega-ton Water System”

The “Mega-ton Water System” project was implemented as national research in Japan (First Program) that aimed at developing sustainable water treatment core technologies necessary for the 21st century.

- The missions of “Mega-ton Water System”
 - 1) energy reduction (20%),
 - 2) water production cost reduction,
 - 3) low environmental impact (reducing chemical for operation).
- The targeted capacity of the Seawater Reverse Osmosis System (“Mega-ton Water System”) is 1,000,000 m³/d.

Advanced Key Technologies

- Development of innovative low pressure seawater RO membrane
 - with micromorphology analysis of the RO membrane functional layer
 - development of production technology of the innovative RO membrane
- Investigation of the brine conversion low pressure multistage high recovery system
- Monitoring of water Quality on biofouling potential.
 - Measurement of mBFR_{TM} (Membrane Biofilm Formation Rate)

Advanced Key Technologies

- Development of innovative low pressure seawater RO membrane
 - with micromorphology analysis of the RO membrane functional layer
 - development of production technology of the innovative RO membrane
- Investigation of the brine conversion low pressure multistage high recovery system
- Monitoring of water Quality on biofouling potential.
 - Measurement of mBFR_{TM} (Membrane Biofilm Formation Rate)

Structure of RO Membrane and Elements

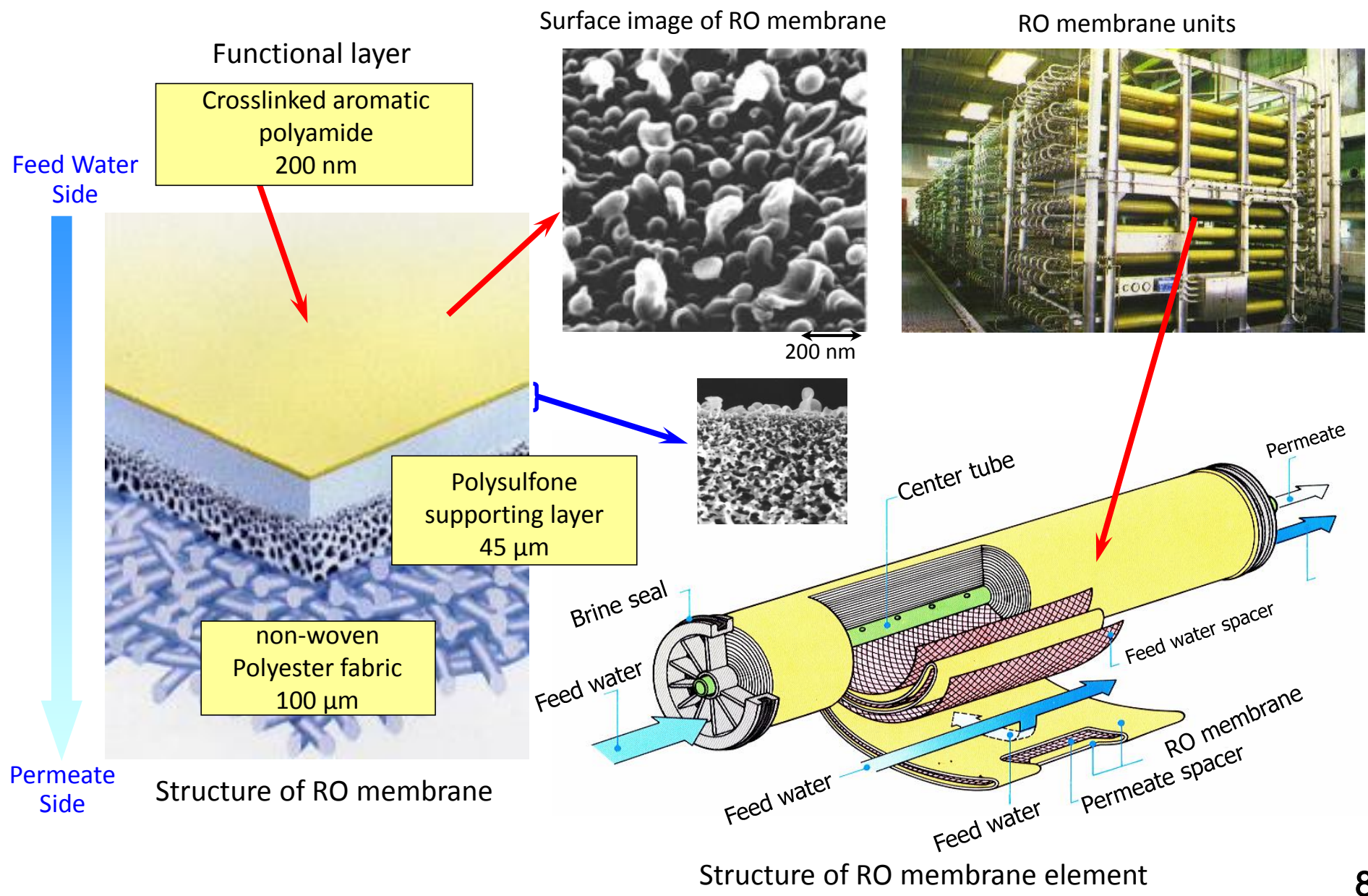

Development History of SWRO Membranes

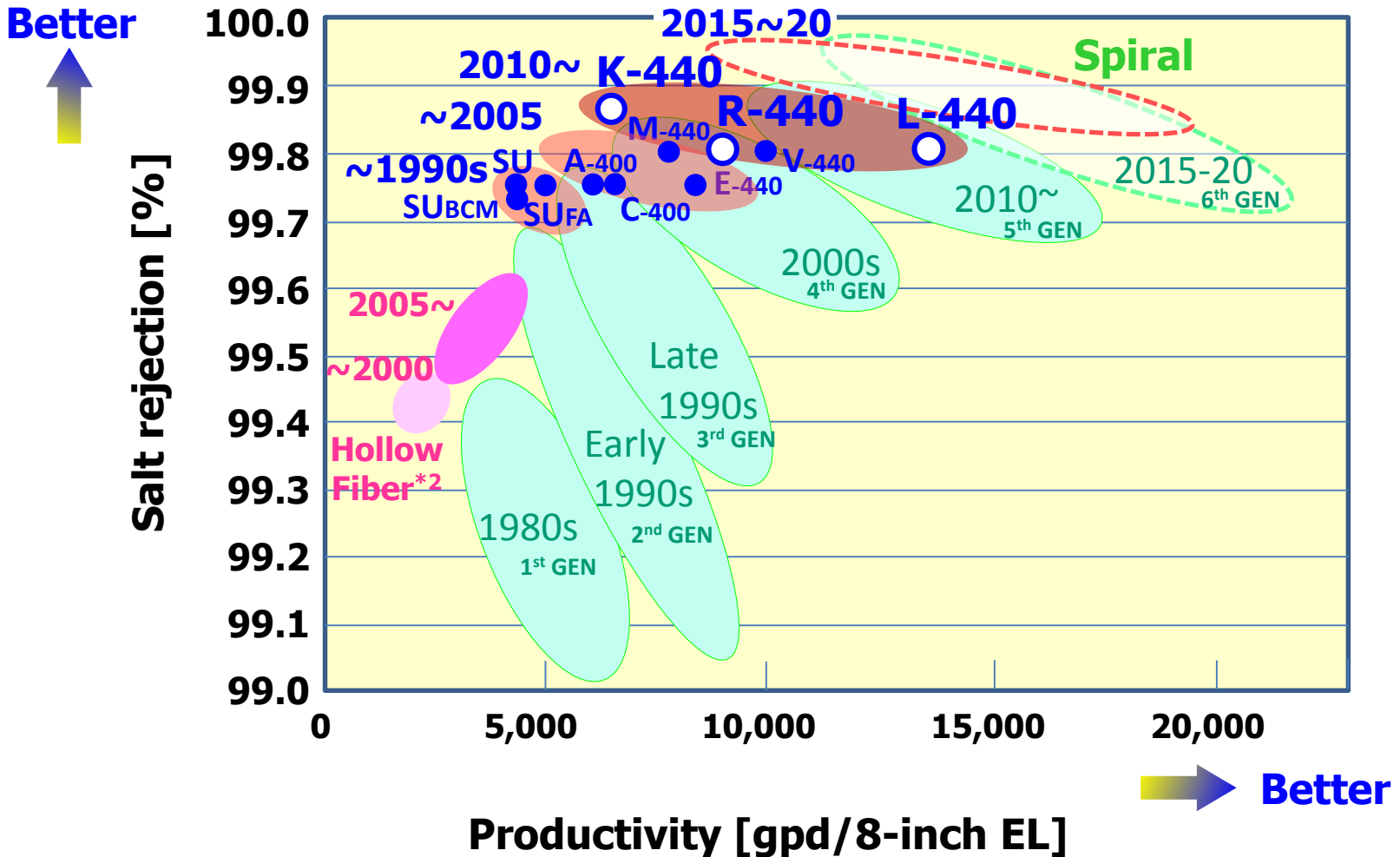

Performance of seawater RO Membrane has been improved by development of membrane materials and micromorphology/

Recent development of SWRO Membranes for conventional plant

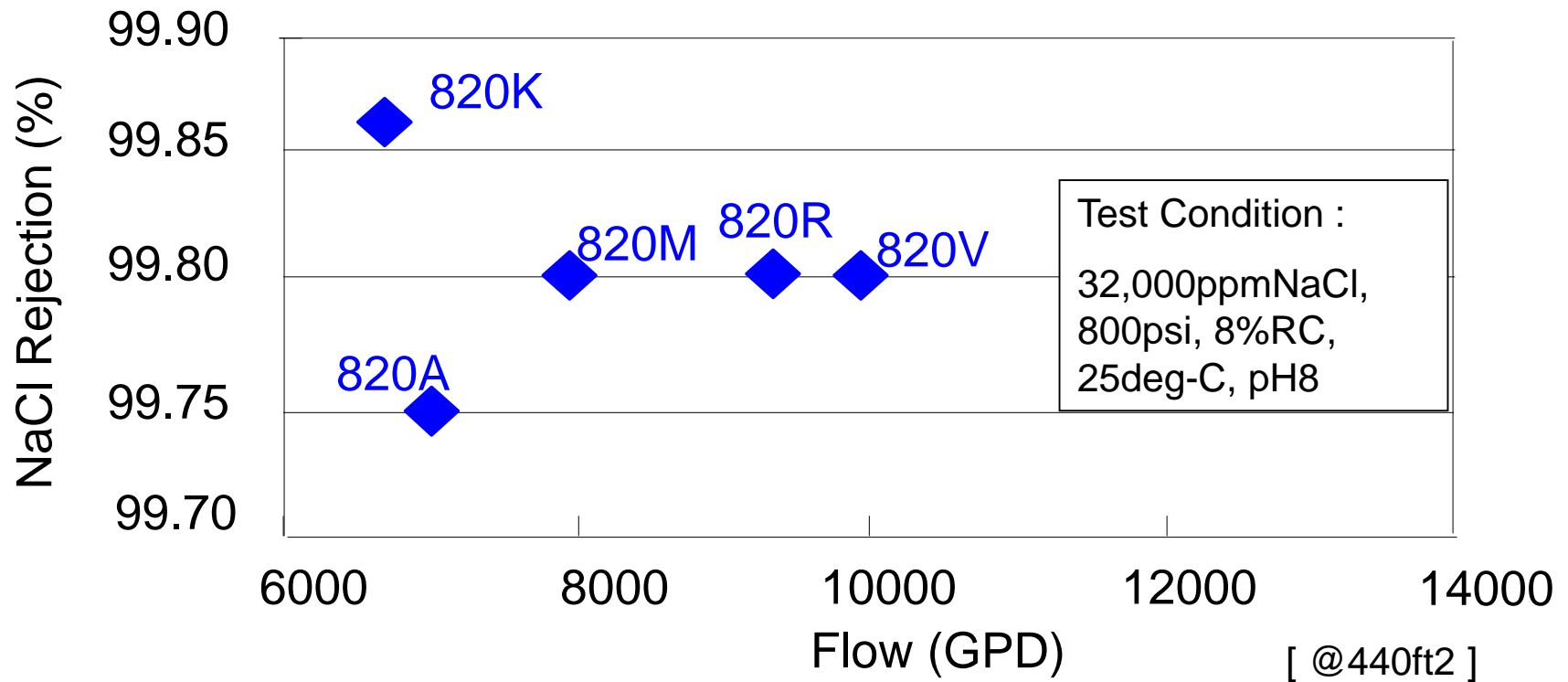

Typical conventional SWRO membrane has wide range of Flow and NaCl Rejection at conventional pressure (800psi).

Schematic Diagram of salt Removal and Water permeation through the Protuberance

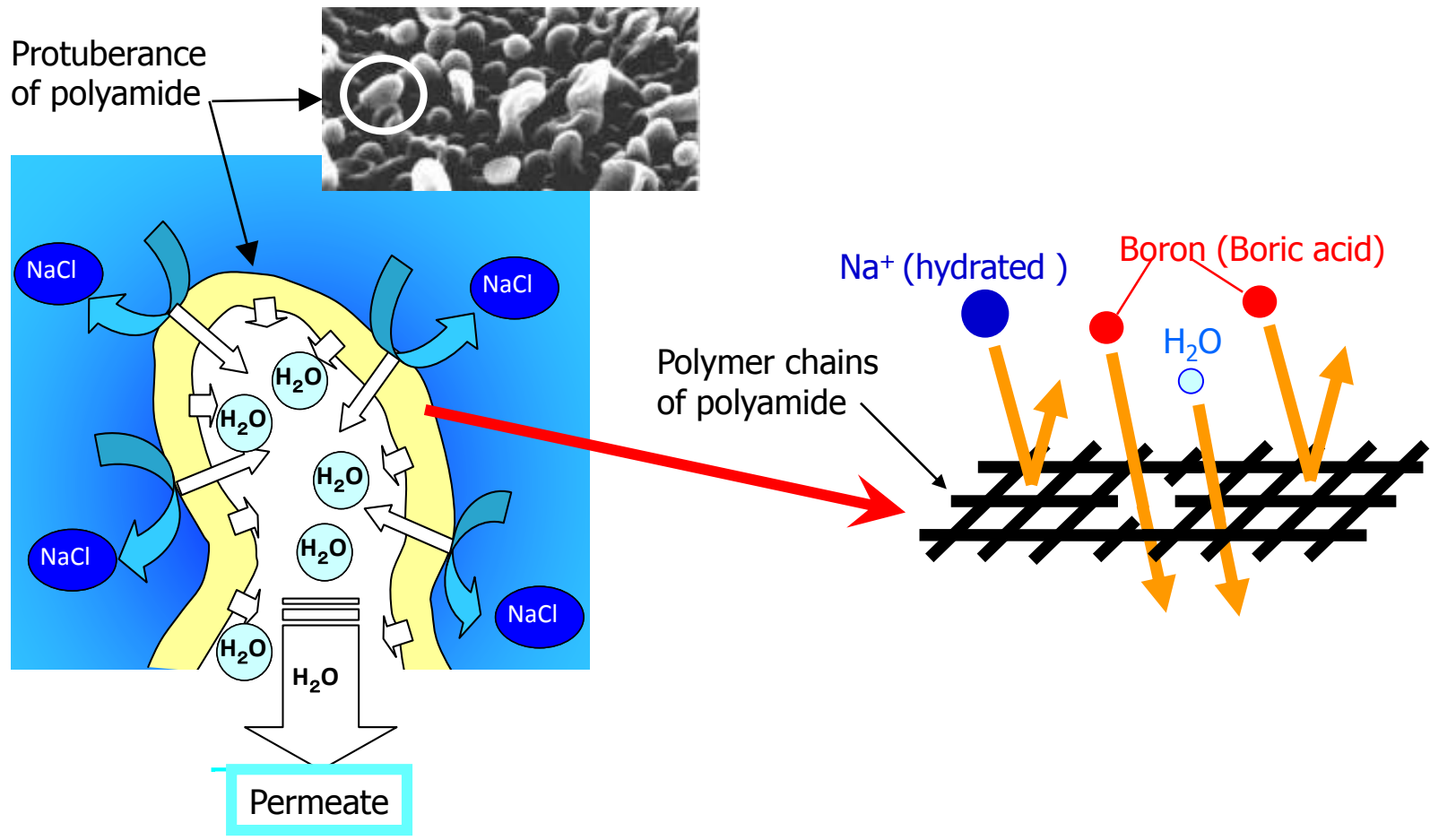

Water permeate through thin layer of polyamide protuberance. Salt and Boron are rejected by narrow pores in protuberance.

Precise Pore Size Estimation of Cross-linked Aromatic Polyamide

Positron Annihilation Lifetime Spectroscopy(PALS)

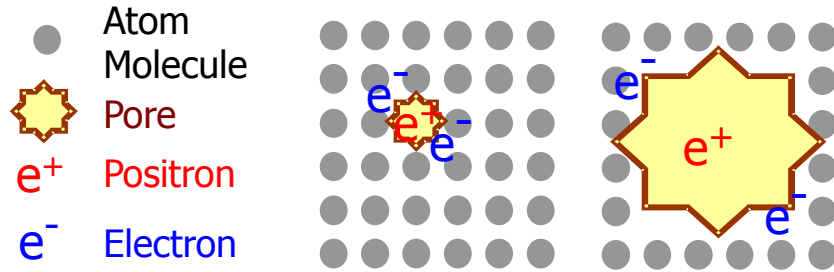

Pore size	Small	Large
Positron Annihilation Lifetime	Short	Long

Confirmation of pore structure with Molecular Dynamics simulation

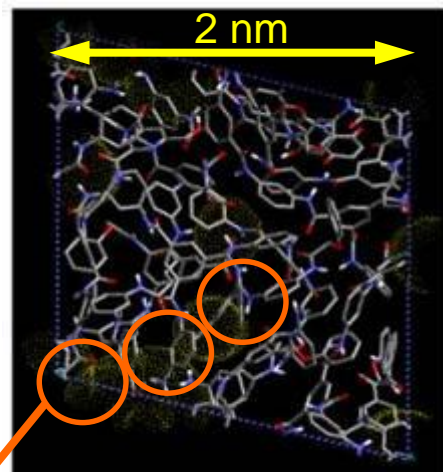

Estimated as 6-8 Å diameter

Relationship of Boron Rejection and Pore Size by PALS

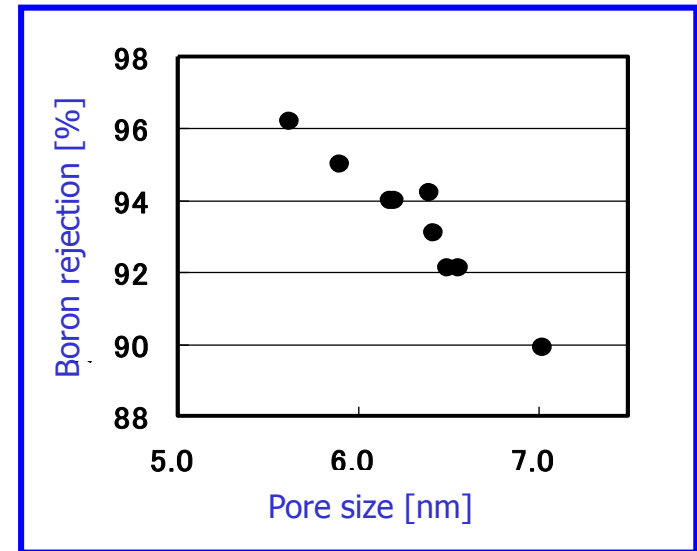

- Pore size of polyamide membrane was estimated by PALS.
- Correlation was observed between pore size and boron rejection.

Technologies for Precise Estimation of “Protuberant Structure”

Conventional method

1. Scanning Electron Microscopy (SEM)

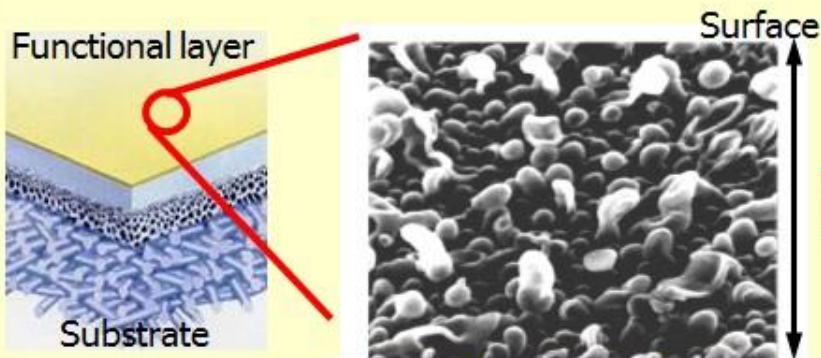

Prepared by vacuum freeze drying

Leading-Edge method

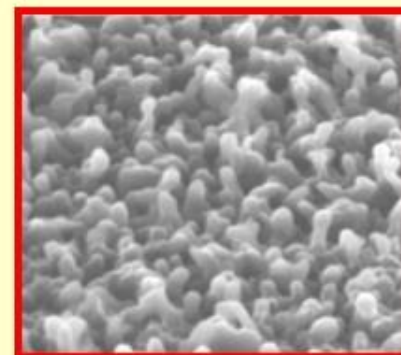

Prepared with pretreatment to keep wet condition

2. Transmission Electron Microscopy (TEM)

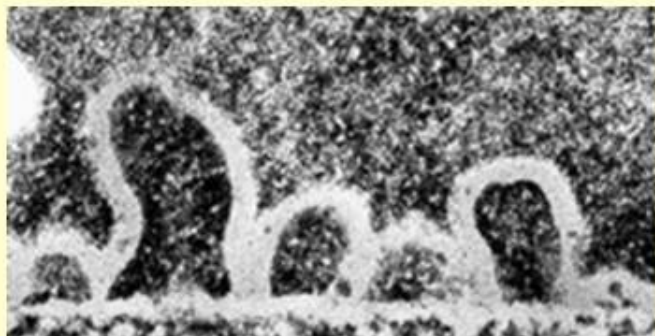

Fixed by Polymer Embedding

(N-S-O)

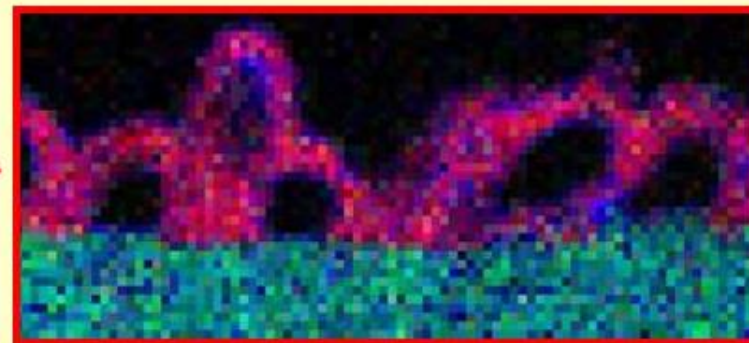

Elemental mapping by STEM-EELS*

*STEM(Scanning Transmission Electron Microscopy), EELS(Electron Energy Loss Spectroscopy)

Structure of protuberance was estimated by SEM and TEM with new technology .

Comparison between Conventional High pressure and Innovative Low Pressure Seawater RO Membrane

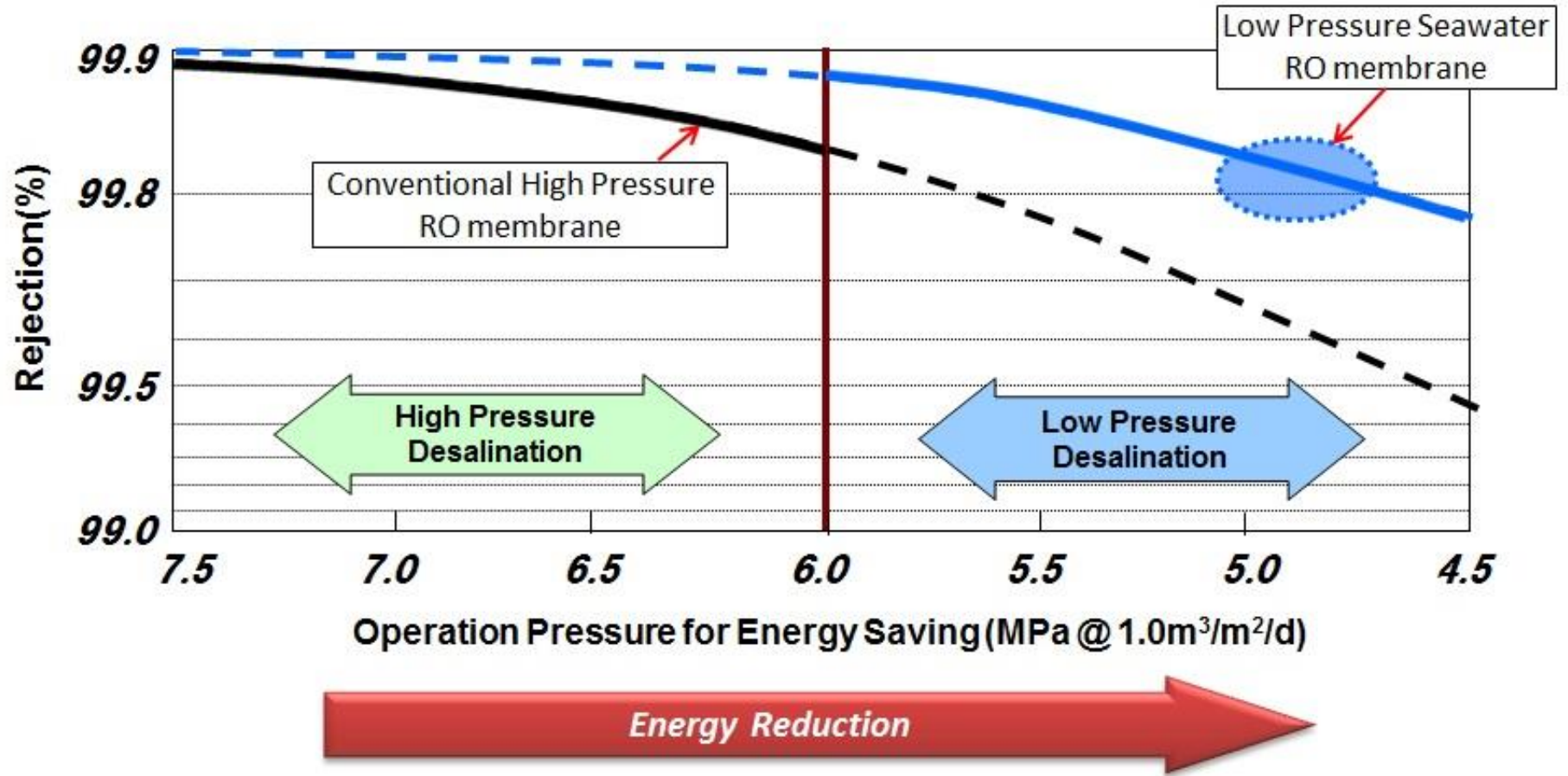

Innovative SWRO membrane will achieve lower operating pressure and energy reduction.

Advanced Key Technologies

- Development of innovative low pressure seawater RO membrane
 - with micromorphology analysis of the RO membrane functional layer
 - development of production technology of the innovative RO membrane
- Investigation of the brine conversion low pressure multistage high recovery system
- Monitoring of water Quality on biofouling potential.
 - Measurement of mBFR_{TM} (Membrane Biofilm Formation Rate)

Comparison of Flow Diagram for Conventional System and LMS

Conventional System

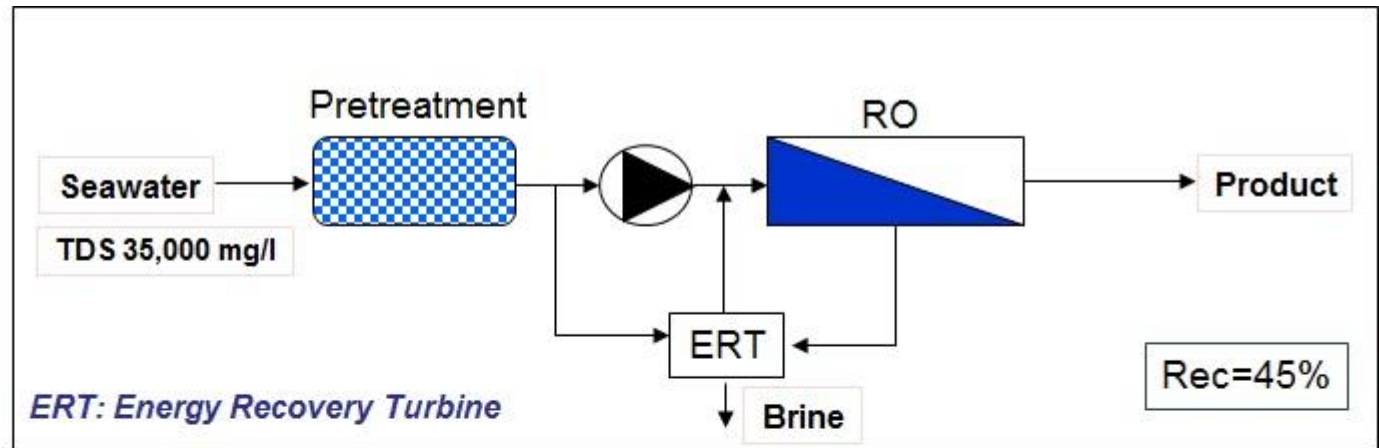

Megaton System (LMS)

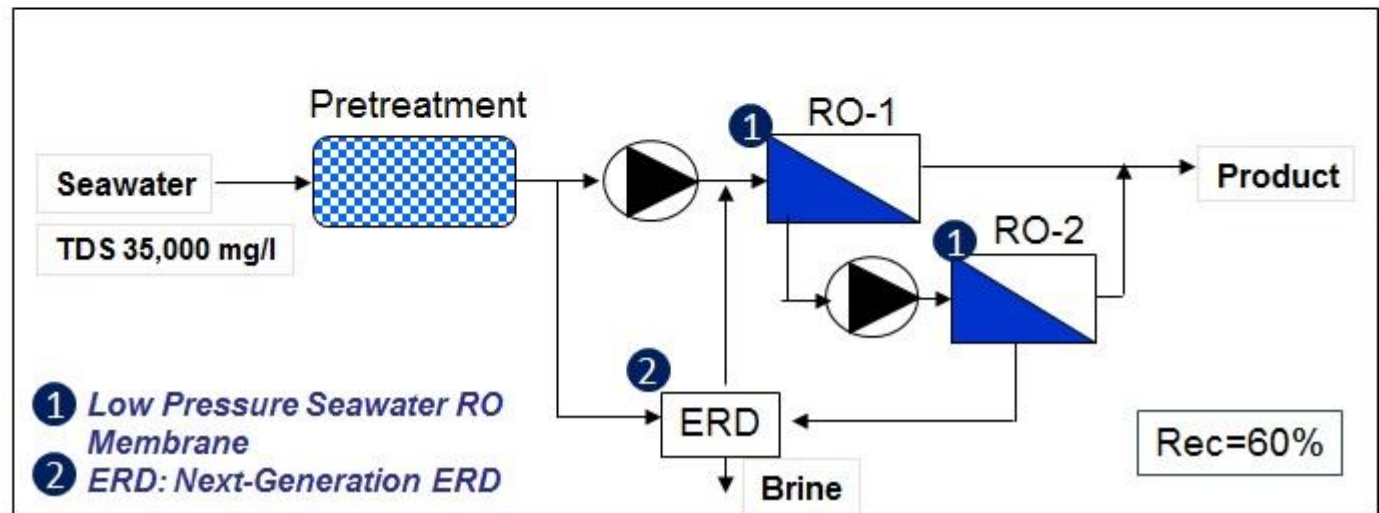

LMS could reach high recovery ratio and low pressure operation comparing to conventional system.

Relationship between Feed Pressure and Feed water Concentration for Conventional System and LMS

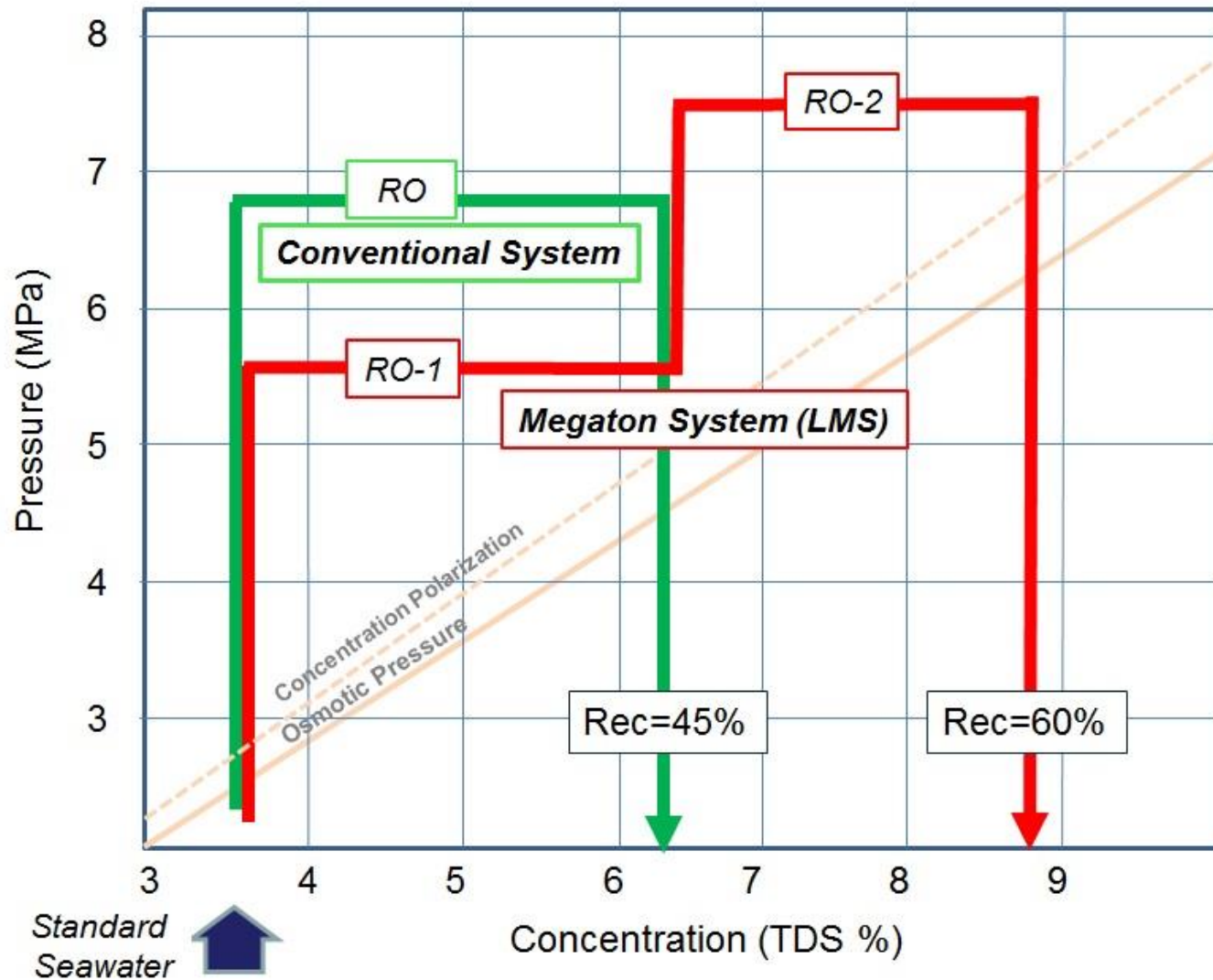

Even though higher recovery ratio, LMS could reduce 1st stage pressure than conventional low recovery ratio system.

Comparison of Pressure and Element Flux between Conventional System and Megaton System (LMS)

Conventional System

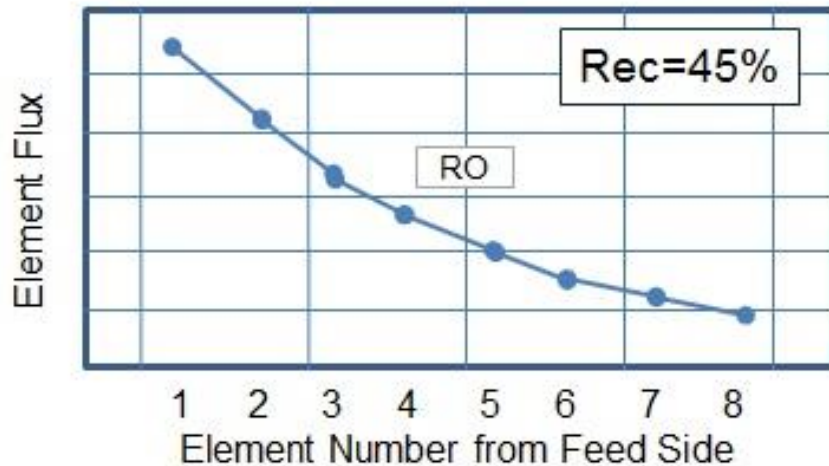
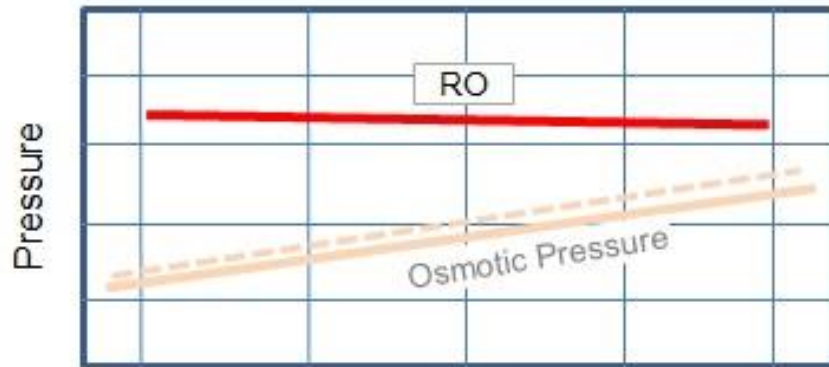

Megaton System (LMS)

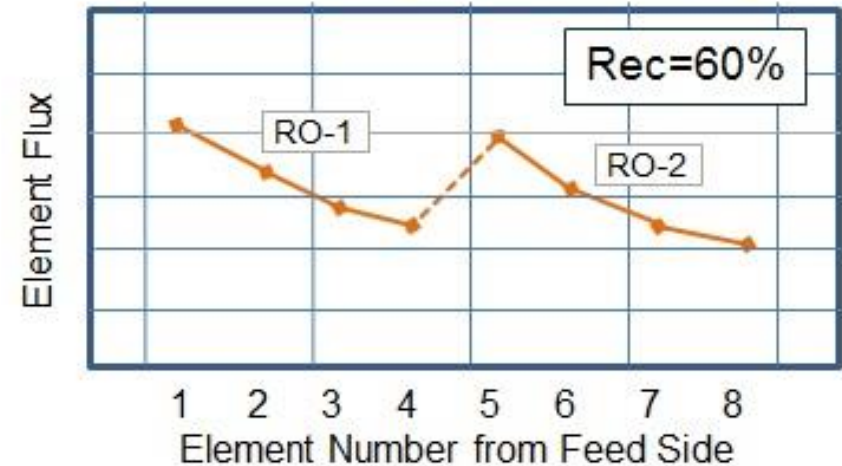
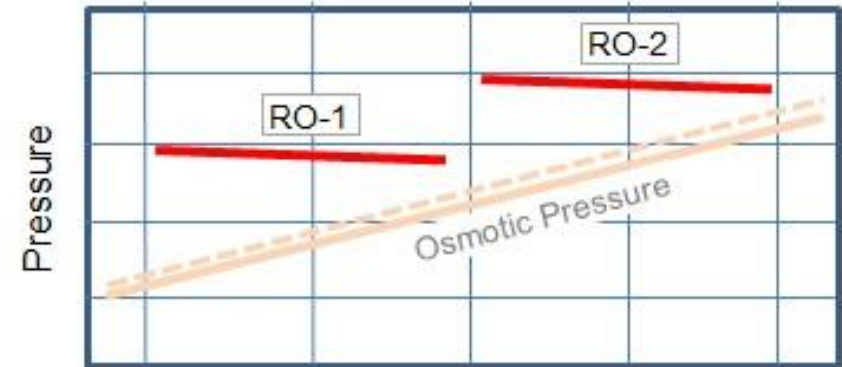

LMS could reduce the flux difference of each elements.

Advanced Key Technologies

- Development of innovative low pressure seawater RO membrane
 - with micromorphology analysis of the RO membrane functional layer
 - development of production technology of the innovative RO membrane
- Investigation of the brine conversion low pressure multistage high recovery system
- **Monitoring of water Quality on biofouling potential.**
 - **Measurement of mBFR_{TM} (Membrane Biofilm Formation Rate)**

Measuring Procedure of mBFR_{TM}

Outline of measurement

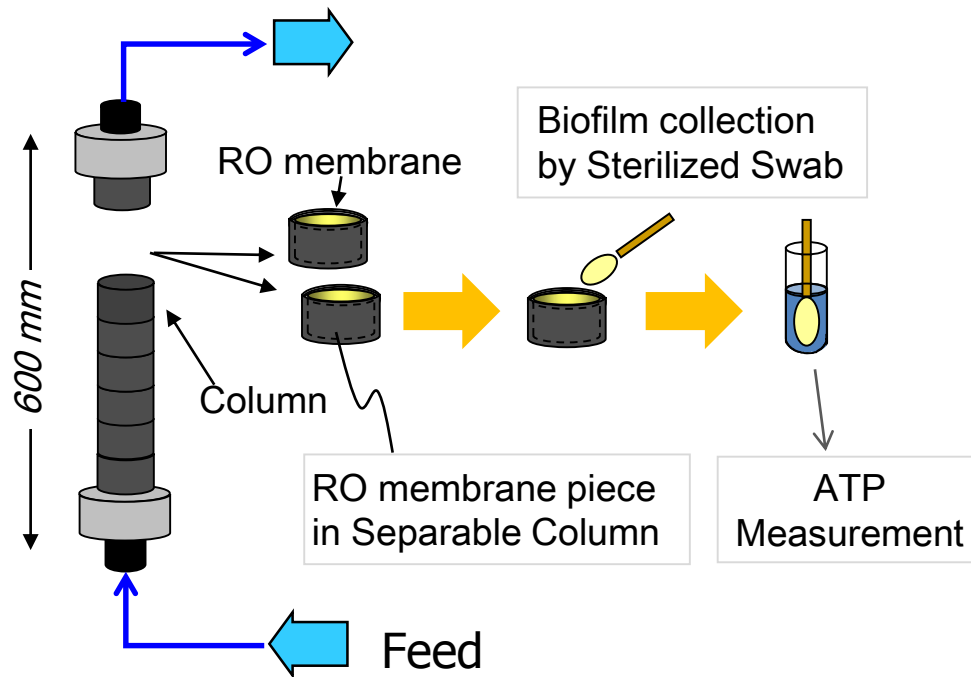

Result example

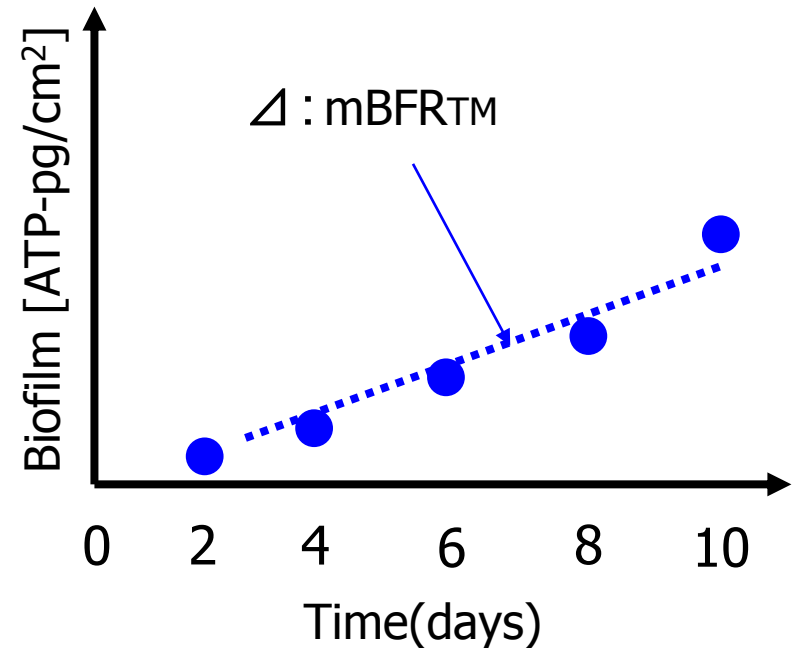

Biofilm is quantified by measuring ATP amount on the carrier
→ Definition: $mBFR_{TM} : \Delta ATP(\text{pg/cm}^2) / \text{Time (day)}$
(ATP : Adenosine Triphosphate)

RO Feed-Brine DP and Biofilm Formation Trend on mBFR Monitor

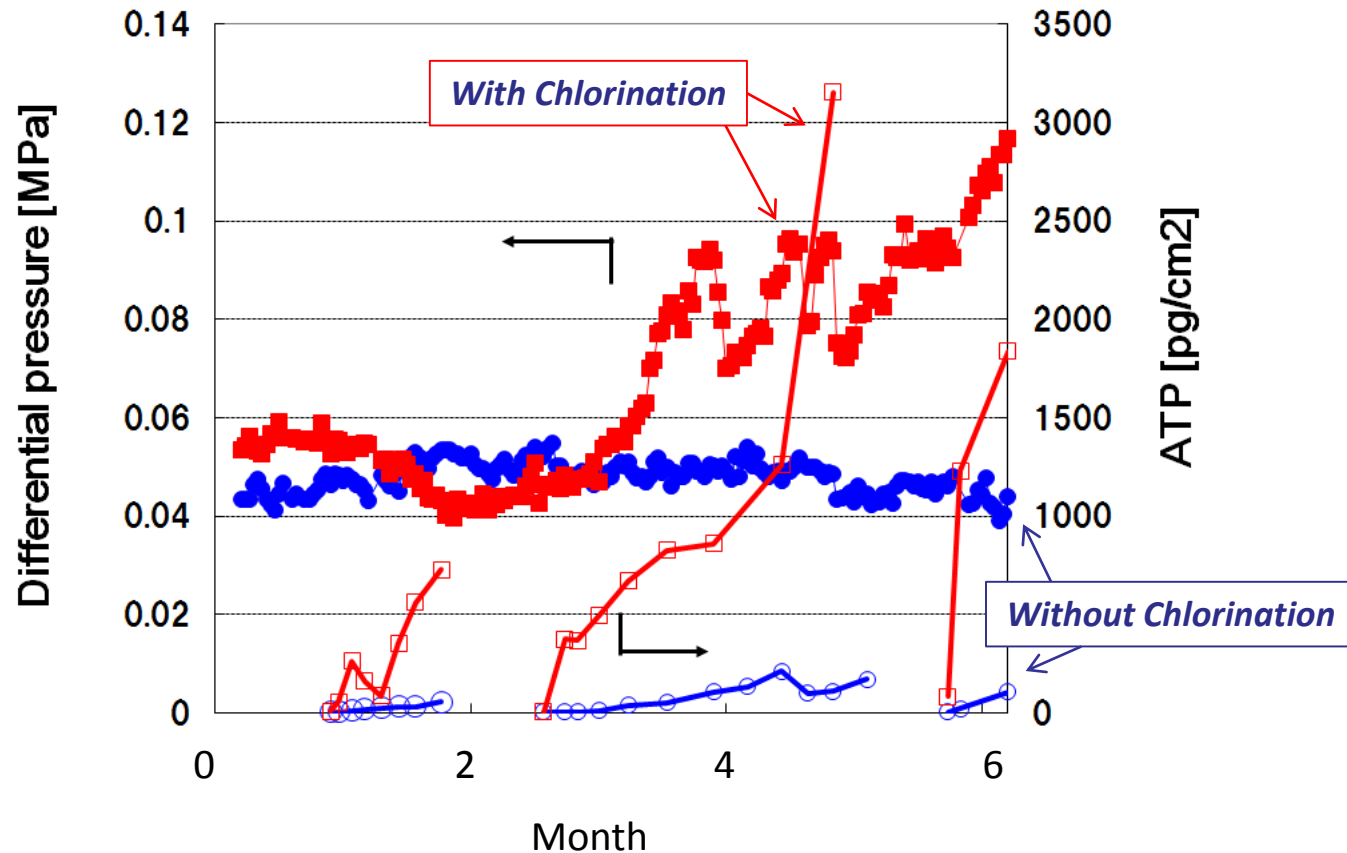

When the mBFR of feed water was small, Differential pressure of element is keeping small value.

Guideline of Biofouling Risk with mBFR

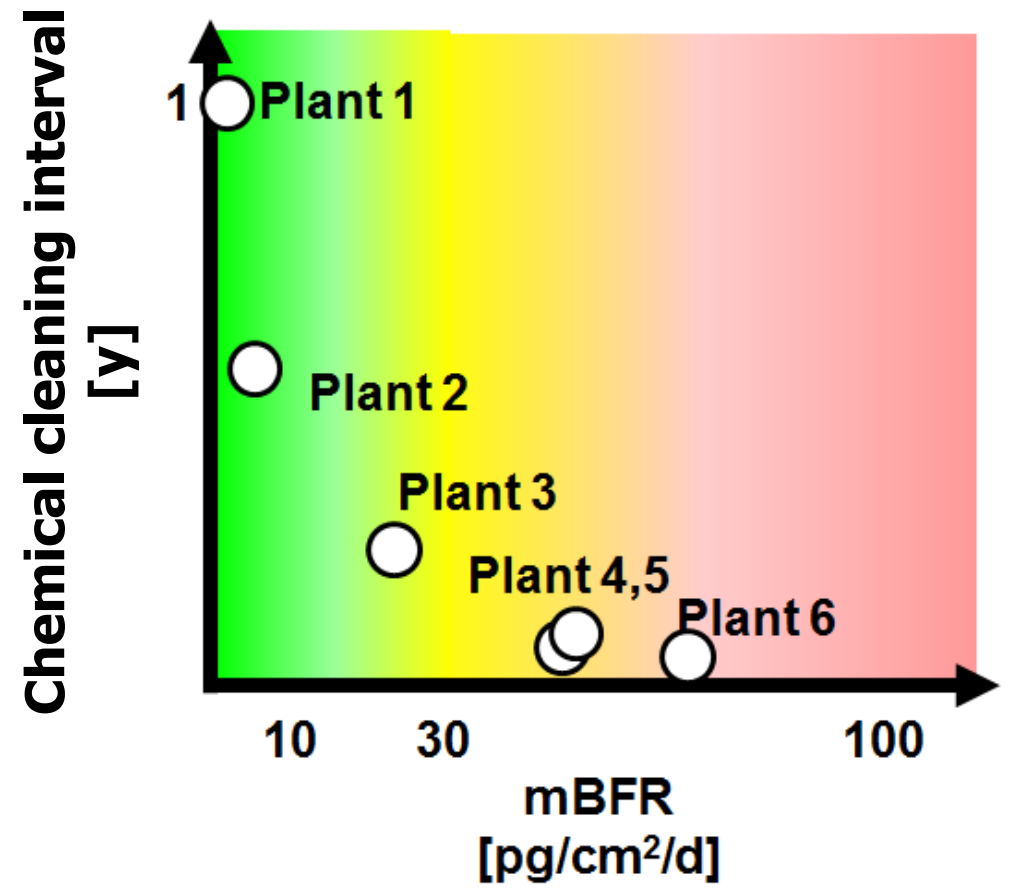
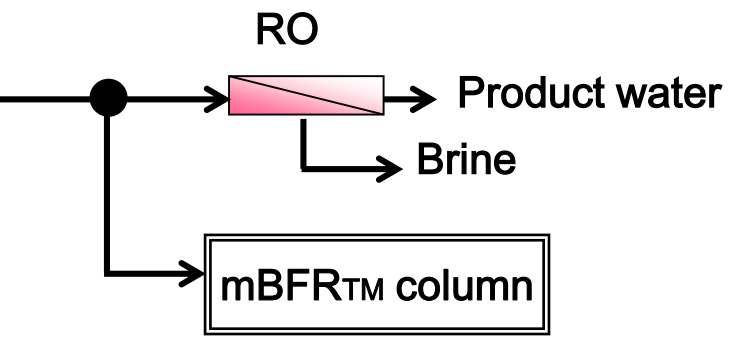

Quantitative RO chemical cleaning interval is predictable based on RO feed water mBFR™ value.

Comparison of Conventional Process and New Process proposed by “Mega-ton Water System” Project

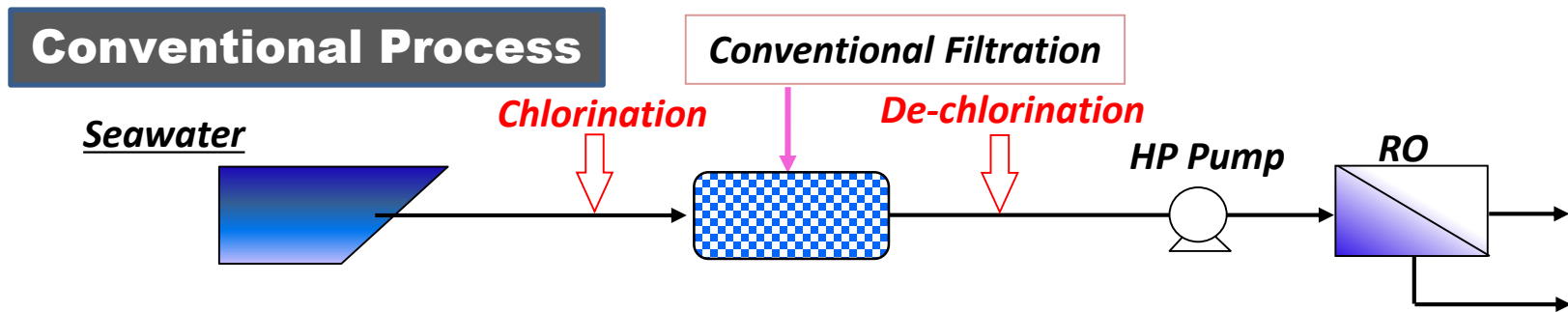

New Process proposed by “Mega-ton Water System” Project

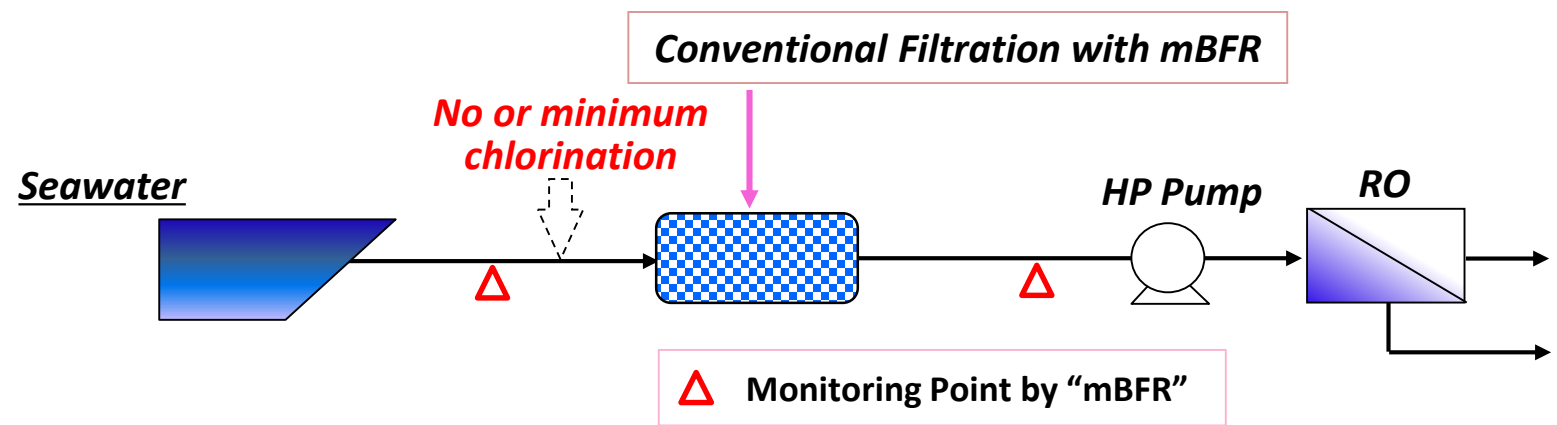

Operation with reducing chemical and mBFR™ monitoring will contribute to stable operation of SWRO plant.

Energy Reduction by Megaton water Technology for 1,000,000m³/d plant



System <Seawater Conc. = 3.5%>	Membrane	ERD	Pump Efficiency	SEC Rate (%)
Conventional (R=45%)	Conventional	Turbo	70-85%	100
Megaton (R=60%)	Low-Pressure SWRO Membrane	New ERD	90%	80

* Benchmark is Conventional Technologies in 2010.

Conclusion

- Innovative low pressure seawater RO membrane was designed and developed with new micromorphology analysis technology, and production technology of the RO membrane.
- The brine conversion low pressure multistage high recovery system (LMS) was developed and this system reached high recovery ratio (60%) at Japan sea area.
- Feed water monitoring system (mBFR_{TM}) was proposed and tested. The mBFR method will contribute to reliable operation.
- Using these Low pressure membrane, LMS and other technology, “Mega-ton Water System” will realize energy reduction (20%), water production cost reduction and low environmental impact.

Production of Water Treatment Membrane in Saudi Arabia



**Signing of Shareholders' Agreement
on February 19, 2014 in Tokyo**
in the presence of
**King Salman bin Abdulaziz Al Saud,
Deputy Crown Prince Mohammed bin
Salman bin Abdulaziz Al Saud,
and
Japanese Prime Minister Shinzo Abe**



- **Toray Membrane Middle East LLC (TMME)** was established in 2014 as a strategic joint venture between **Abunayyan Holding (AHC)**, a leading water and power company group based in the Kingdom
- TMME is aiming at **manufacturing of RO membrane elements in Saudi Arabia**, and **provide with membrane technology solutions to the MENA region.**

About TMME



Name: Toray Membrane Middle East LLC
Shareholder: Toray Membrane Europe AG : 50%
Abunayyan Holding Co. (AHC) : 50%
Business: RO, NF, UF and MBR Membranes
Location: Dammam 3rd Industrial Zone
Capital: 45 million SAR
Territory: Middle East and North Africa
Function: Production, Sales, Marketing, Technical Service

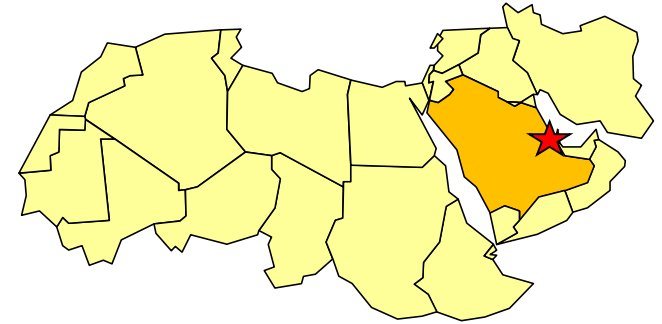

Evaluation Machine



Factory



Automated Production

**The Global Largest Scale Production in Dammam
started its manufacturing in year 2015**

Toray's Activities toward Saudi Vision 2030



1. Local Production



Toray Membrane Middle East LLC (TMME) in Damman, started production of RO Membrane Elements in June 2015

3. Saudization



RO Membrane Elements made in Saudi Arabia, made by Saudi Arabian

2. Exporting of High Quality Products



Exporting High Quality RO Membrane Elements to MENA Region

4. Supplying Water in Saudi Arabia



Many of desalination plants in Saudi Arabia started water production by using TMME RO Membrane Elements.



Thank You for your Attention